



FICHE DE PRESENTATION DES CASQUES PREMIUM (NORME FIA 8859-2015) PRESENTATION FORM FOR PREMIUM HELMETS (FIA STANDARD 8859-2015)

1. GENERALITES / GENERAL

101. CONSTRUCTEUR / MANUFACTURER

STILO S.R.L.

- a) Adresse Address VIALE MAJNO 45, 20122 MILANO
b) Téléphone Phone +39 035 690 040
c) E-mail E-mail INFO@STILO.IT

102. DATE DE LA FICHE DE PRESENTATION / PRESENTATION FORM DATE

Date / Date 19.12.2023

103. PHOTO DU CASQUE / PICTURE OF THE HELMET



104. MODELE ET VERSIONS / MODEL AND VERSIONS

- a) Modèle Model WRX VENTI CARBON / WRX VENTI CARBON N
b) Type de casque Type of helmet Intégral / Full-face
c) Versions disponibles Available versions HELMET WITH OR WITHOUT INTEGRATED PLUGS, WITH OR WITHOUT VISOR

Nom Name WRX VENTI CARBON / CARBON N

Nom Name -

Nom Name -

Description Description WITH OR WITHOUT INTEGRATED PLUGS AND/OR VISOR

Description Description

Description Description

A1)



B1)

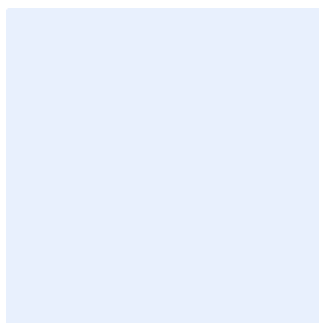

C1)

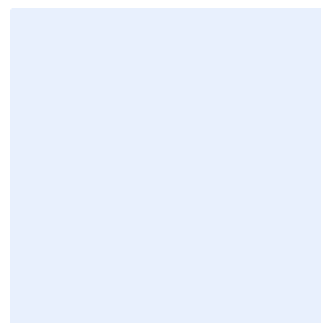

Marque
Make **STILO**

Modèle
Model **WRX VENTI CARBON**

Homologation N°

PH.127.24-C

105. TAILLES DISPONIBLES / SIZES AVAILABLE

Tailles / Sizes

XS54, S55, S56, M57, M58, L59, L60, XL61, XXL62, XXL63, XXL64

2. DETAILS DU CASQUE / DETAILS OF THE HELMET

201. VUES / VIEWS

D1) Vue de face / Front view



D2) Vue du Côté Droite / Right Side view



D3) Vue de haut / Top view

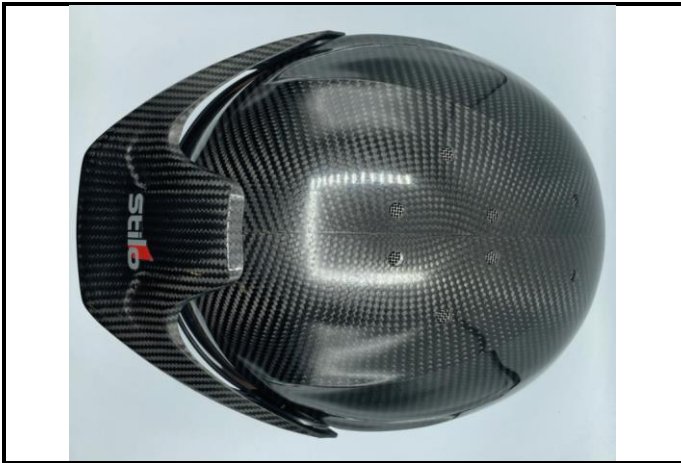

202. NOMBRE ET POSITION DES TROUS DE VENTILATION / NUMBER AND POSITION OF VENTILATION HOLES

Menton Chin	Top Top	Trous pour boire Drinking hole
Nombre de trous Number of holes	8 max	Oui/Yes
	Inclus Included	

3. ACCESSOIRES DISPONIBLES / AVAILABEL ACCESSORIES

E1) EAR CUPS STILO (WITH OR WITHOUT SPEAKER)



E2) EAR PADS



E3) CLIPS SIDE PORT CONNECTOR

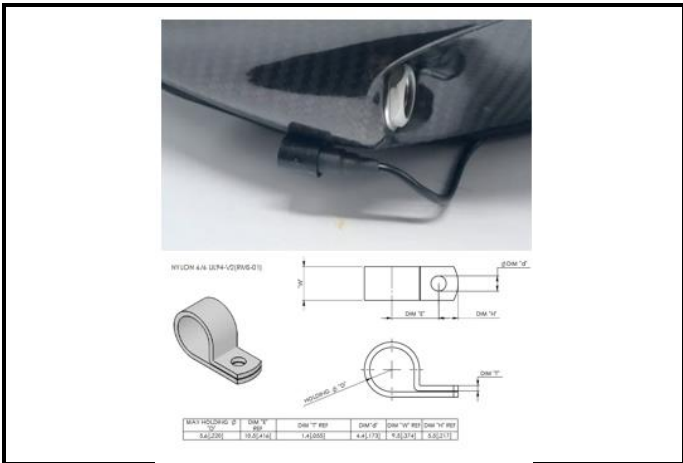

E4) CLIPS SIDE PORT CONNECTOR



E5) CHIN DRINK SYSTEM



E6) SIDE PORT DRINK SYSTEM



Marque
Make **STILO**

Modèle
Model

WRX VENTI CARBON

Homologation N°

PH.127.24-C

E7) INTEGRATED COMM



E8) SIDE PORT VENTILATION SYSTEM



E9) SHORT PEAK



E10) LONG PEAK



E11) SUNSHIELD

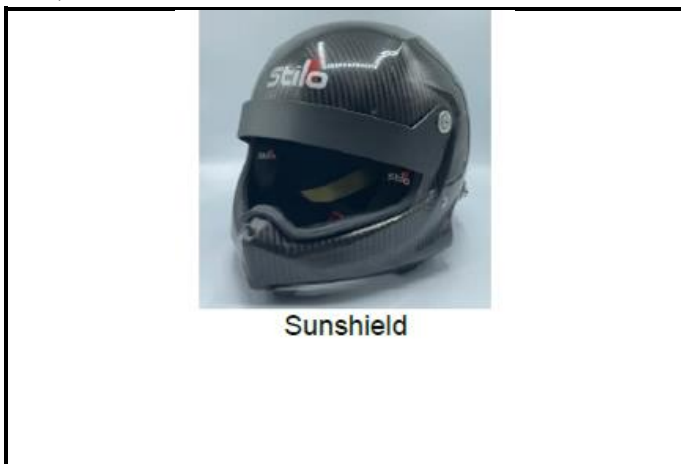

E12) Visor Sunshield (short) closed cockpit car



E13) SHORT TOP-AIR



E14) LONG TOP-AIR (FIXED OR ADJUSTABLE)



E15) MODULAR TOP-AIR INLET (FOR LONG AND SHORT

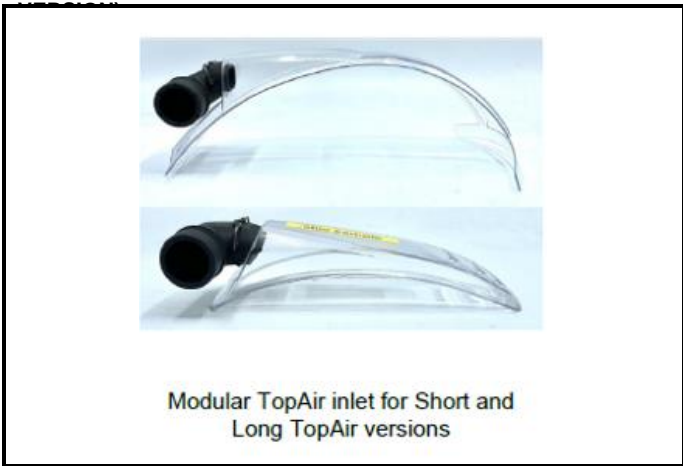

E16) RADIO/INTERCOM CONNECTION KIT

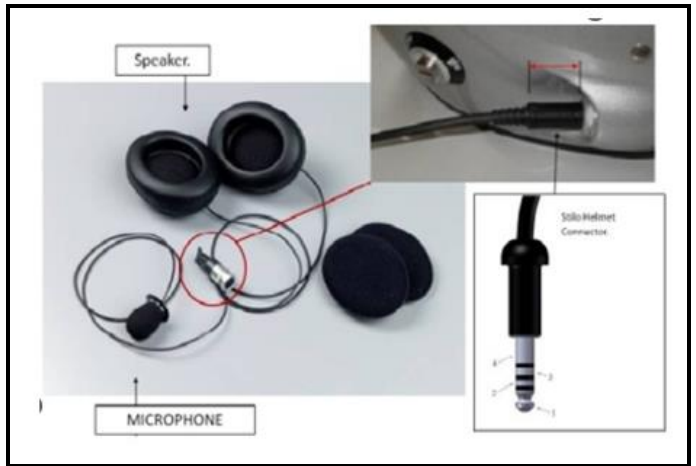

E17) WL-KEY



E18) HELMET SKIRT



E19) CHIN FLAP



E20)

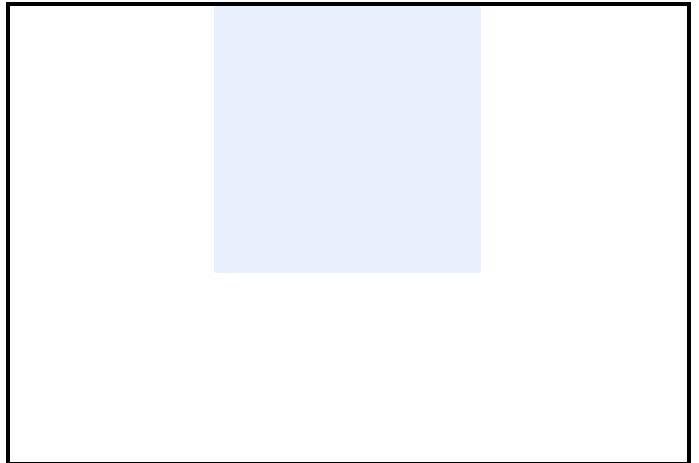

E21)

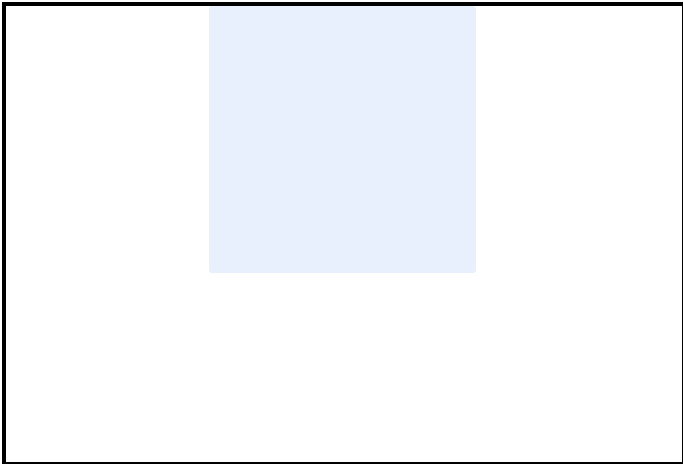

E22)

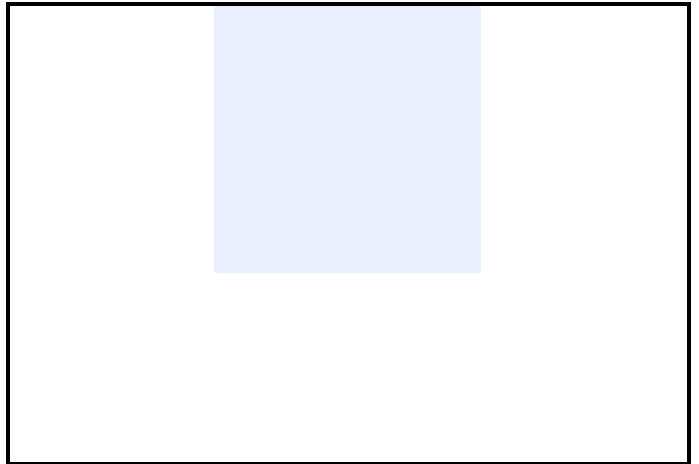

E23)

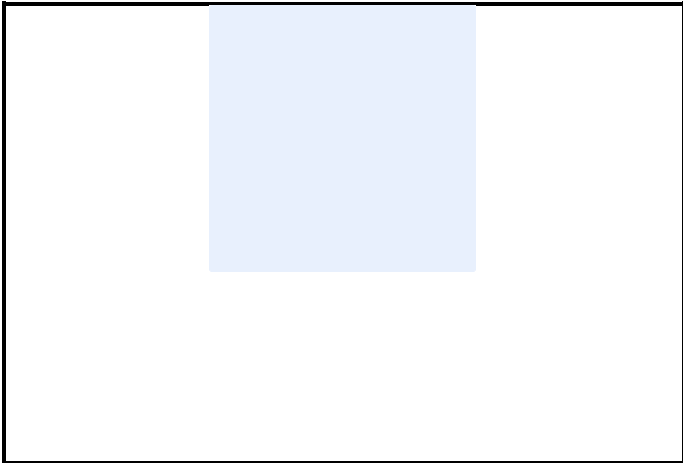

E24)

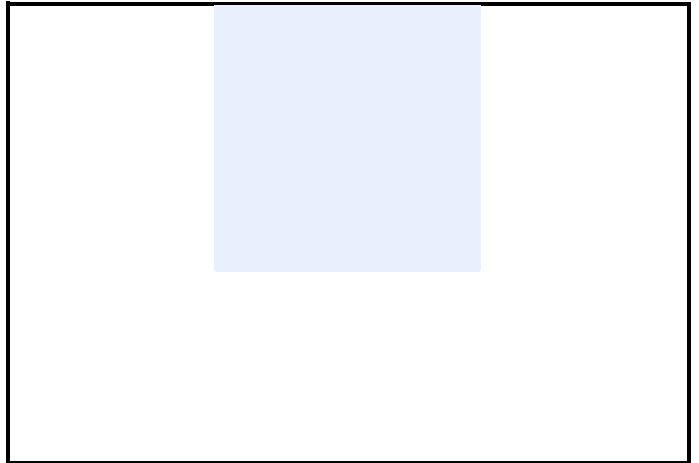

INFORMATIONS COMPLEMENTAIRES / COMPLEMENTARY INFORMATION

8 optional top ventilation holes

