



FEDERATION INTERNATIONALE DE L'AUTOMOBILE

Homologation N°

PH.005.24-O

FICHE DE PRESENTATION DES CASQUES PREMIUM (NORME FIA 8859-2024) PRESENTATION FORM FOR PREMIUM HELMETS (FIA STANDARD 8859-2024)

1. GENERALITES / GENERAL

101. CONSTRUCTEUR / MANUFACTURER

STILO SRL

- a) Adresse / Address **VIALE MAJNO 45, 20122 MILANO**
- b) Téléphone / Phone **+39 035 690 040**
- c) E-mail / E-mail **INFO@STILO.IT**

102. DATE DE LA FICHE DE PRESENTATION / PRESENTATION FORM DATE

Date / Date **04/10/2024**

103. PHOTO DU CASQUE / PICTURE OF THE HELMET



104. MODELE ET VERSIONS / MODEL AND VERSIONS

- a) Modèle / Model **WRC VENTI4 COMPOSITE / TROPHY VENTI4 COMPOSITE**
- b) Type de casque / Type of helmet **Face Ouverte / Open-face**
- c) Versions disponibles / Available versions

Nom / Name	WRC VENTI4 COMPOSITE / WRC VENTI4 COMPOSITE N	Nom / Name	TROPHY VENTI4 COMPOSITE / TROPHY VENTI4 COMPOSITE N	Nom / Name
Description / Description	HELMET WITH BOOM, WITH OR WITHOUT INTEGRATED PLUGS	Description / Description	HELMET WITH OR WITHOUT BOOM, WITH OR WITHOUT INTEGRATED PLUGS	Description / Description

A1)



B1)



C1)

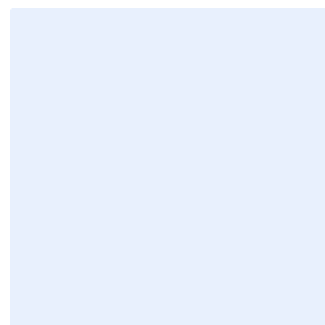

105. TAILLES DISPONIBLES / SIZES AVAILABLE

Tailles / Sizes

54, 55, 57, 58, 59, 61, 63, 64

2. DETAILS DU CASQUE / DETAILS OF THE HELMET

201. VUES / VIEWS

D1) Vue de face / Front view



D2) Vue du Côté Droite / Right Side view



D3) Vue de haut / Top view



202. MECANISME DE VERROUILLAGE DE LA VISIERE / VISOR LOCKING MECHANISM

a) Ce casque a-t-il une visière ? **Oui / Yes** **Non / No**
Does the helmet have a visor?

D1) Vue du mécanisme de verrouillage en position de visière fermée
/ View of the locking mechanism in closed visor position

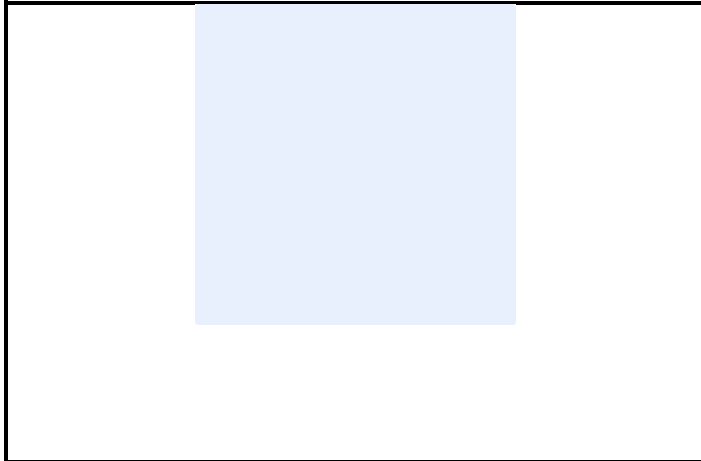

D2) Vue du mécanisme de verrouillage en position de visière ouverte
/ View of the locking mechanism in open visor position

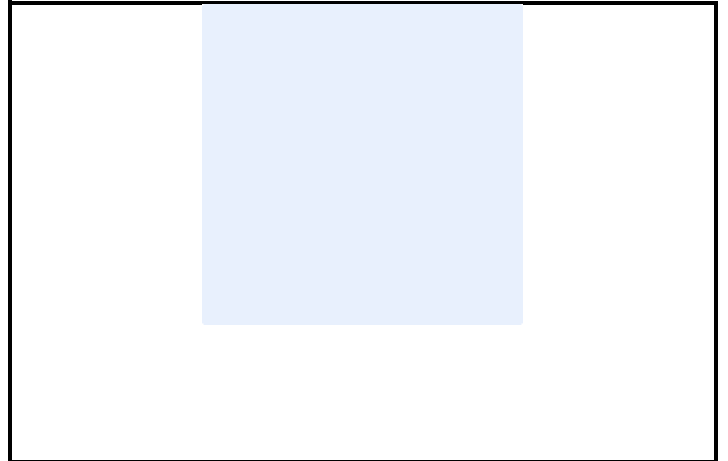

203. NOMBRE ET POSITION DES TROUS DE VENTILATION / NUMBER AND POSITION OF VENTILATION HOLES

Menton Chin		Top Top		Trous pour boire Drinking hole
Nombre de trous Number of holes	no	Nombre de trous Number of holes	8 max	Inclus Included
				Oui/Yes

3. ACCESSOIRES DISPONIBLES / AVAILABLE ACCESSORIES

E1) EAR CUPS STILO (WITH OR WITHOUT SPEAKER)



E2) EAR PADS



E3) CLIPS SIDE PORT CONNECTOR

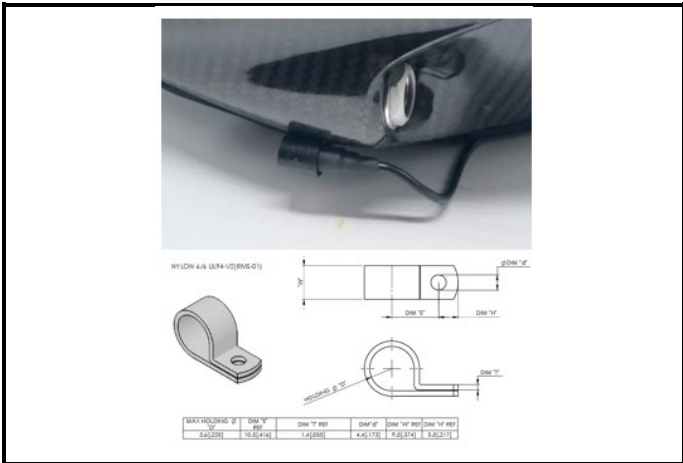

E4) CLIPS SIDE PORT CONNECTOR



E5) WL-KEY



E6) SIDE PORT DRINK SYSTEM



E7) INTEGRATED COMM

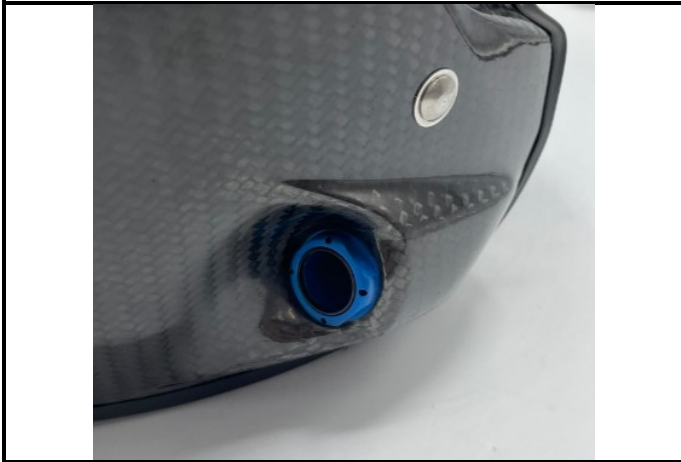

E8) Standard side air



E9) DRAG SIDE AIR



E10) PEAK (PLASTIC OR CARBON)

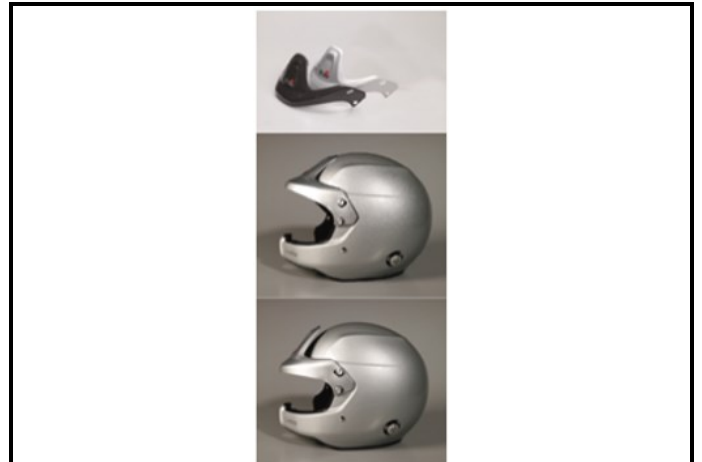

E11) VISOR SUNSHIELD



E12) EJECT



E13) RADIO/INTERCOM CONNECTION KIT



E14) RADIO/INTERCOM CONNECTION KIT



E15) VENTILATION SYSTEM MAGNETIC FITTING



E16) MODULAR TOP-AIR SHORT+LONG VERSION

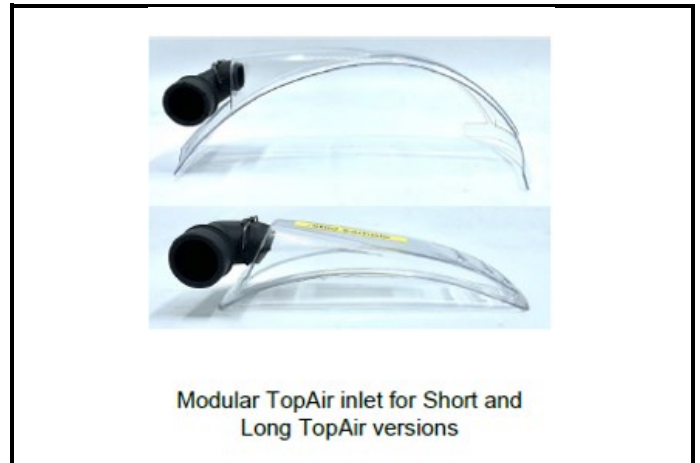

E17) SHORT TOP-AIR



E18) LONG TOP-AIR (FIXED OR ADJUSTABLE)



Marque
Make **STILO**

Modèle
Model

WRC VENTI4 COMPOSITE

Homologation N°

PH.005.24-O

E19) TOP VENTILATION HOLES (8 MAX)

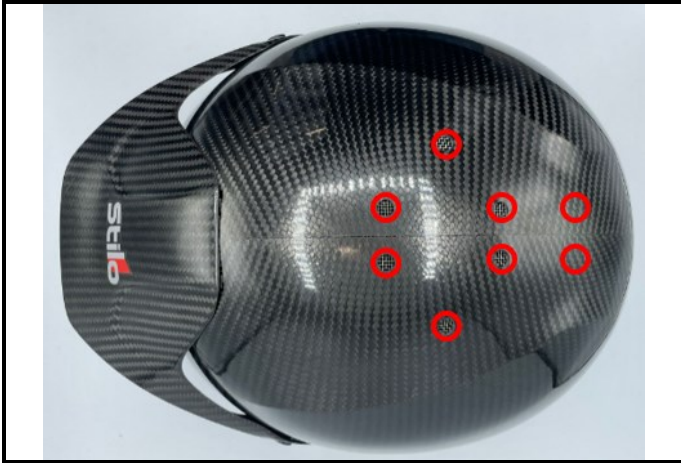

E20)

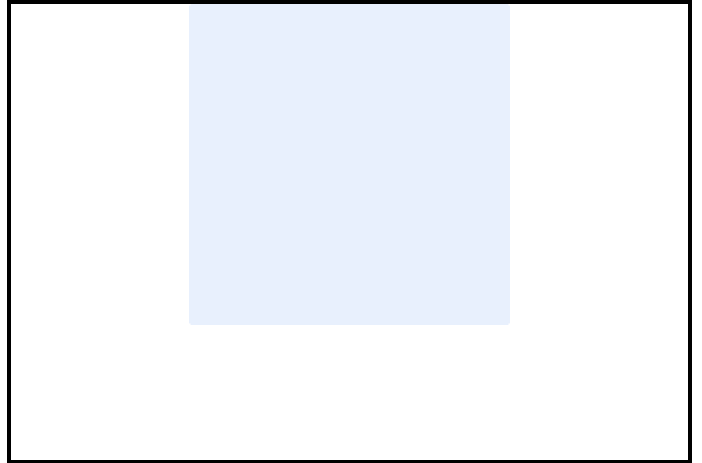

Marque
Make **STILO**

Modèle
Model **WRC VENTI4 COMPOSITE**

Homologation N°

PH.005.24-O

INFORMATIONS COMPLEMENTAIRES / COMPLEMENTARY INFORMATION

