



FICHE DE PRESENTATION DES CASQUES HAUTE PERFORMANCE (NORME FIA 8860-2018)
PRESENTATION FORM FOR ADVANCED HELMETS (FIA STANDARD 8860-2018)

1. GENERALITES / GENERAL

101. CONSTRUCTEUR / MANUFACTURER

STILO

- a) Adresse / Address **VIALE MAJNO 45, 20122 MILANO**
- b) Téléphone / Phone **+39 035 690 040**
- c) E-mail / E-mail **INFO@STILO.IT**

102. DATE DE LA FICHE DE PRESENTATION / PRESENTATION FORM DATE

Date / Date **30/08/2024**

103. PHOTO DU CASQUE / PICTURE OF THE HELMET



104. MODELE ET VERSIONS / MODEL AND VERSIONS

- a) Modèle / Model **ST6 ZERO ABP**
- b) Type de casque / Type of helmet **Intégral / Full-face**
- c) Avec protection balistique avancée / With advanced ballistic protection **Oui / Yes**
- d) Versions disponibles / Available versions

Nom / Name **ST6 ZERO FN ABP**

Description / Description **FULL FACE HELMET WITH INTEGRATED PLUG**

A1)



Nom / Name **ST6 ZERO F ABP**

Description / Description **FULL FACE HELMET WITH/WITHOUT INTEGRATED PLUG**

B1)



Nom / Name

Description / Description

C1)

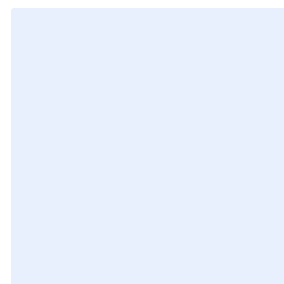

105. TAILLES DISPONIBLES / SIZES AVAILABLE

Tailles / Sizes

XS54, S55, S56, M57, L58, L59, L60, XL61, 2XL63, 3XL64

2. DETAILS DU CASQUE / DETAILS OF THE HELMET

201. VUES / VIEWS

D1) Vue de face / Front view



D2) Vue du Côté Droite / Right Side view



D3) Vue de haut / Top view



D4) Etiquette d'homologation / Homologation label

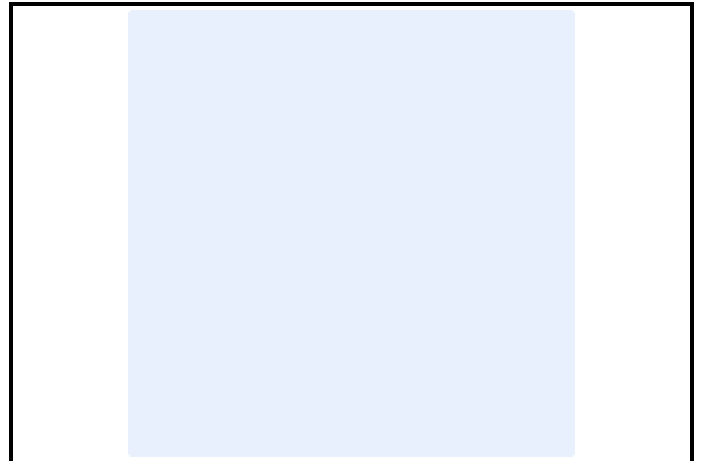

202. NOMBRE ET POSITION DES TROUS DE VENTILATION / NUMBER AND POSITION OF VENTILATION HOLES

| Menton Chin | | Top Top | | Trous pour boire Drinking hole | |
|------------------------------------|---------------------------------|------------------------------------|---------------|-----------------------------------|----------------|
| Nombre de trous Number of holes | 8 max (optiona | Nombre de trous Number of holes | 10 max | Inclus Included | Oui/Yes |

203. MECANISME DE VERROUILLAGE DE LA VISIERE / VISOR LOCKING MECHANISM

- a) Ce casque a-t-il une visière ? **Oui / Yes** **Non / No**
Does the helmet have a visor?

D1) Vue du mécanisme de verrouillage en position de visière fermée
/ View of the locking mechanism in closed visor position



D2) Vue du mécanisme de verrouillage en position de visière ouverte
/ View of the locking mechanism in open visor position



204. POSITION DE VENTILATION / VENTILATION POSITION

- a) Ce casque a-t-il une position de ventilation ? **Oui / Yes** **Non / No**
Does the helmet have a Ventilation position?

D1) Vue latérale de la position de ventilation /
Side View of the ventilation position

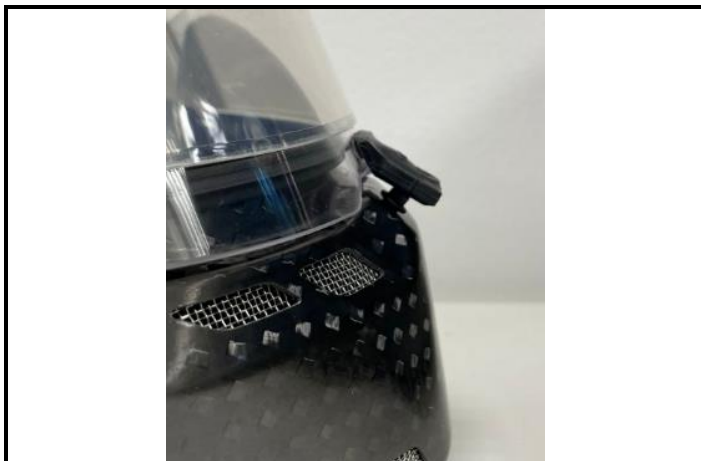

D2) Vue de face de la position de ventilation /
Front View of the ventilation position

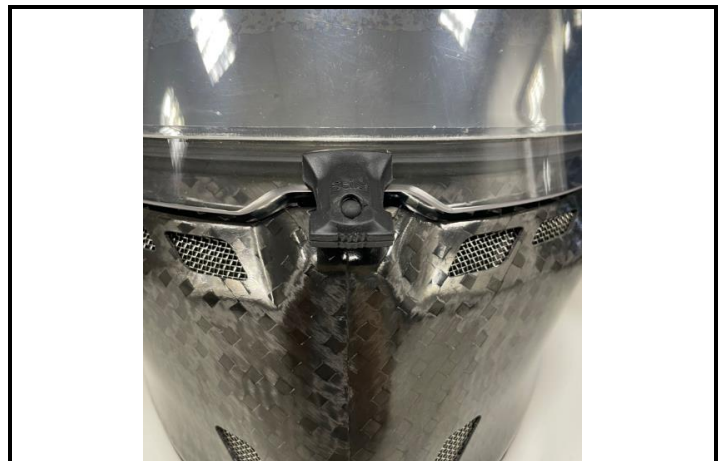

3. ACCESSOIRES DISPONIBLES / AVAILABLE ACCESSORIES

E1) EAR CUPS STILO (WITH OR WITHOUT SPEAKER)



E2) EAR PADS



E3) CLIPS SIDE PORT CONNECTOR

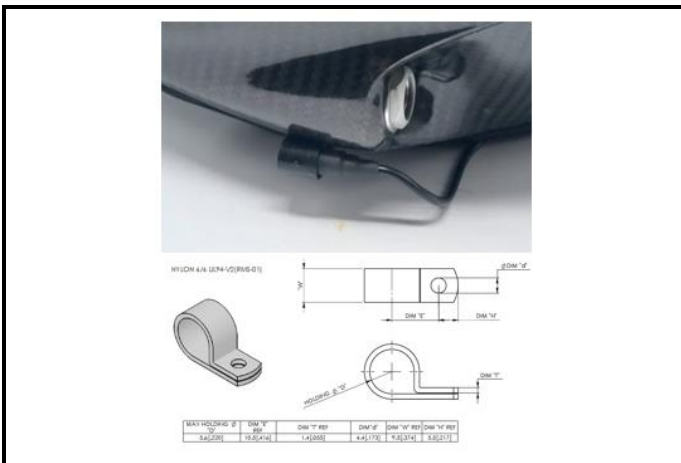

E4) CLIPS SIDE PORT CONNECTOR

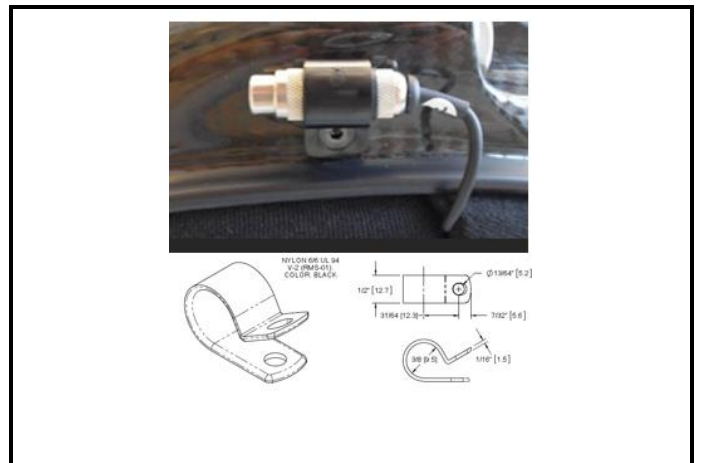

E5) CHIN DRINK SYSTEM



E6) SIDE PORT DRINK SYSTEM



E7) INTEGRATED COMM



E8) STANDARD SIDE AIR



E9) DRAG SIDE AIR



E10) CHIN SPOILER SHORT



E11) CHIN SPOILER STD

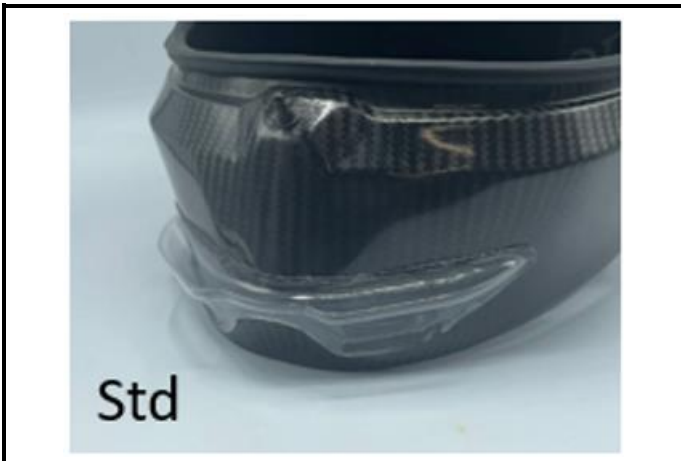

E12) REAR SPOILER V1

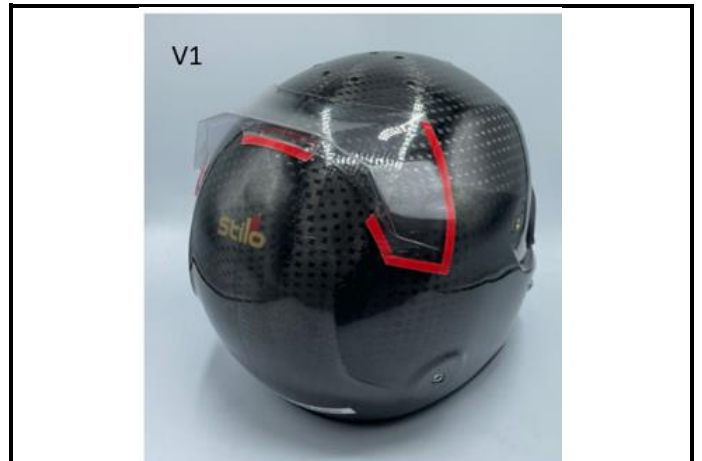

E13) REAR SPOILER V2

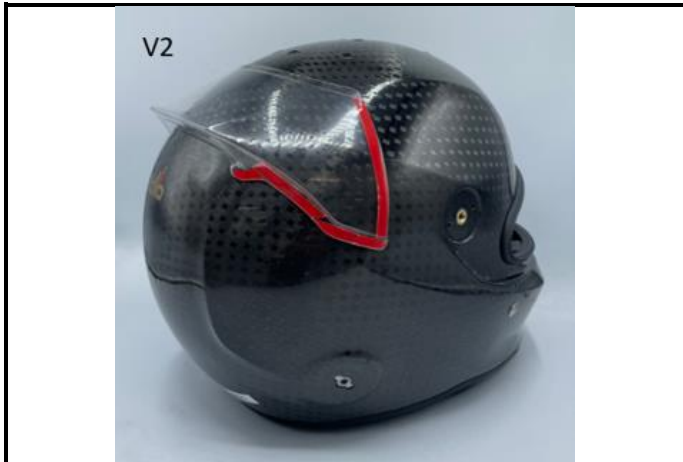

E14) REAR SPOILER V3



E15) REAR SPOILER V4

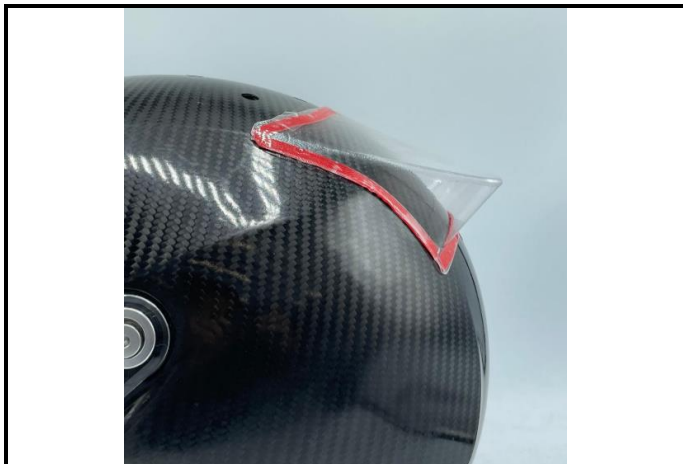

E16) VISOR SUNSHIELD (injected-formed) closed cockpit



E17) SHORT TOP-AIR



E18) LONG TOP-AIR (FIXED OR ADJUSTABLE)



E19) MODULAR TOP-AIR (LONG+SHORT)



E20) RADIO/INTERCOM CONNECTION KIT



E21) RADIO/INTERCOM CONNECTION KIT



E22) WL-KEY



E23) HELMET SKIRT



E24) CHIN FLAP



E25) HELMET CAMERA GEN2.5LW



E26) EJECT



E27) TOP-AIR VENT INTAKES



E28) SUNSHIELD



E29) Visor trim Drag-race



E30) Helmet skirt drag race

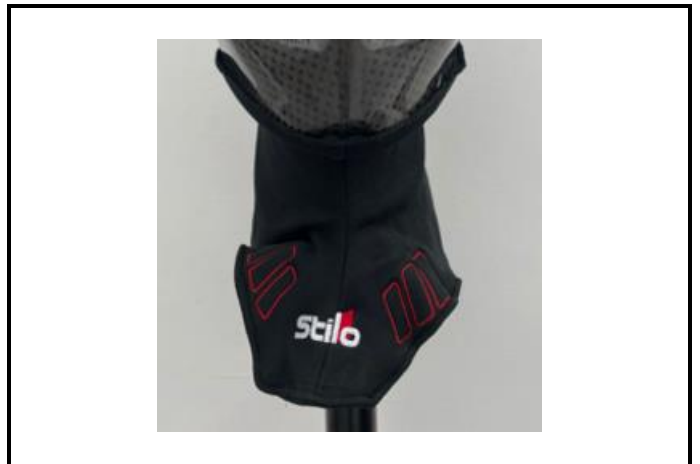

E31) Chin cover



E32) Chin ventilation



E33) Chin ventilation+side to top ventilation



E34) Ventilation system Magnetic fitting



E35)

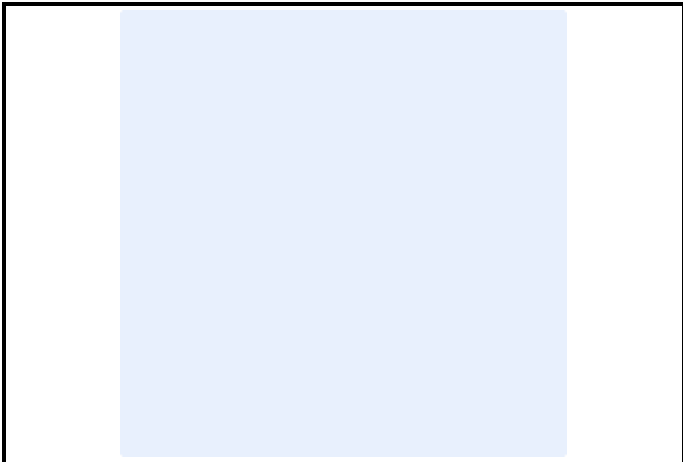

E36)

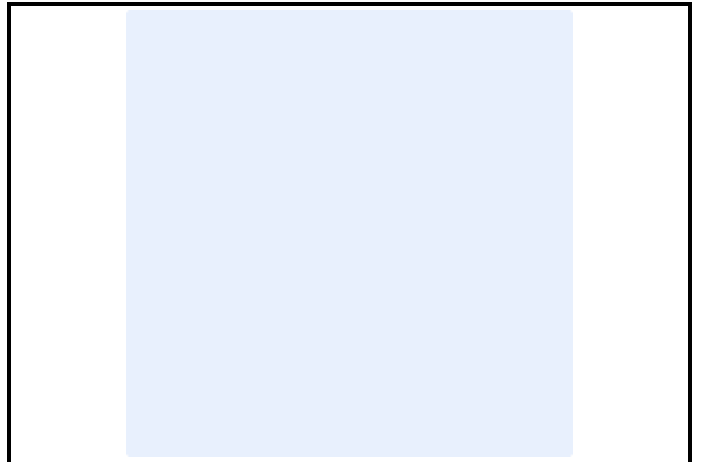

Marque
Make

STILO

Modèle
Model

ST6 ZERO ABP

Homologation N°

AH.031.24-C-ABP

E37)

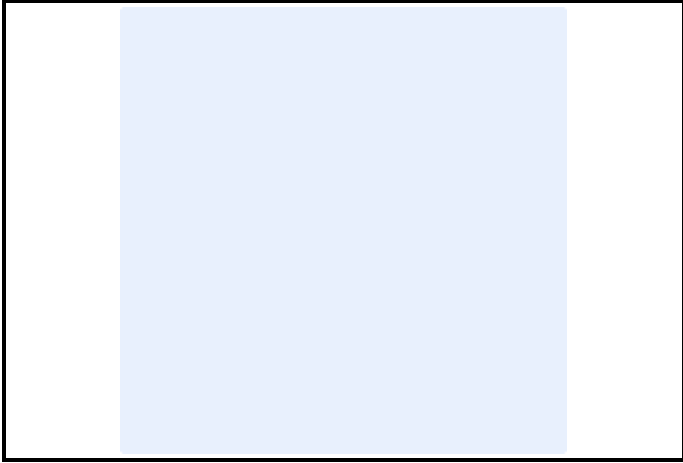

E38)

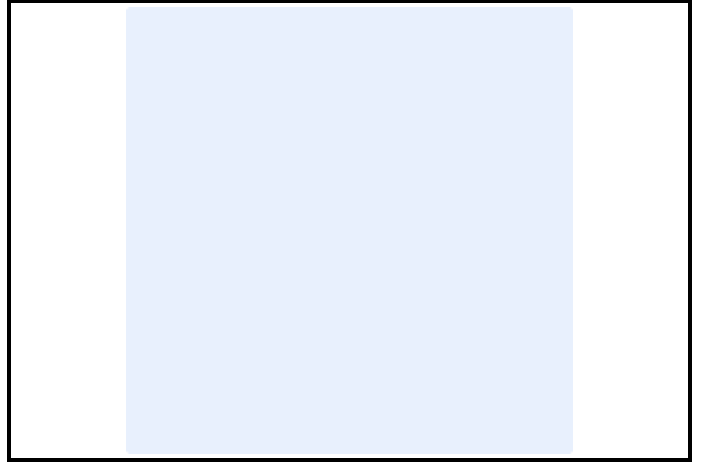

E39)

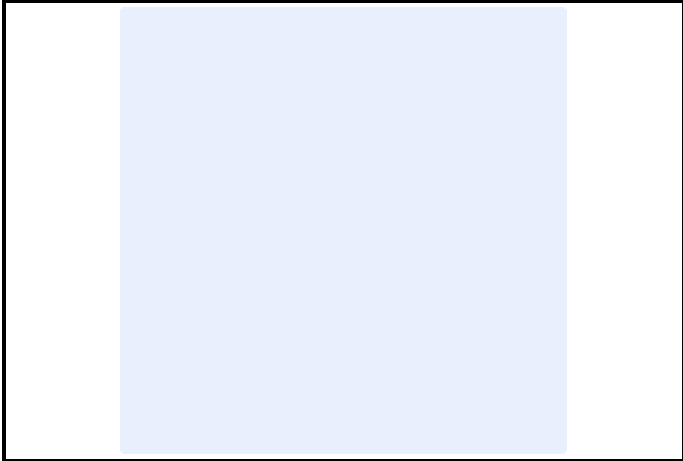

E40)

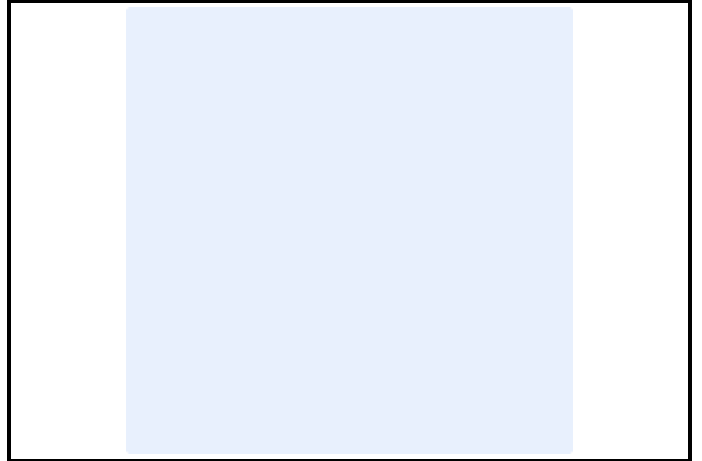

E41)

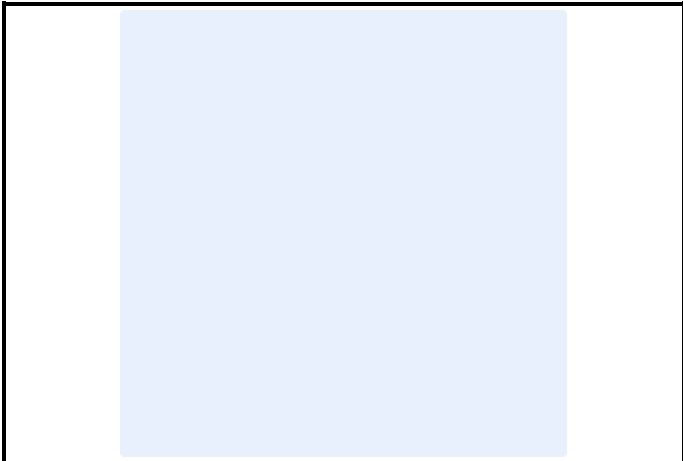

E42)

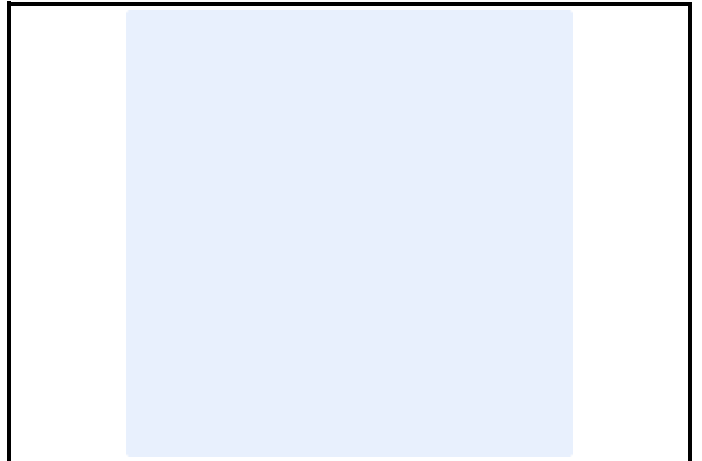

Marque
Make

STILO

Modèle
Model

ST6 ZERO ABP

Homologation N°

AH.031.24-C-ABP

E43)

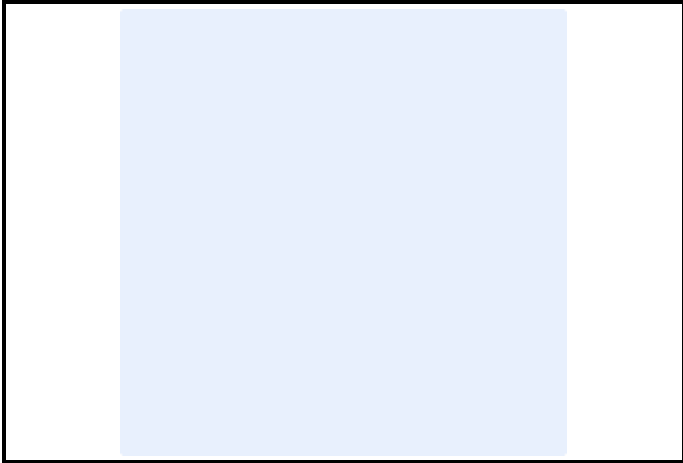

E44)

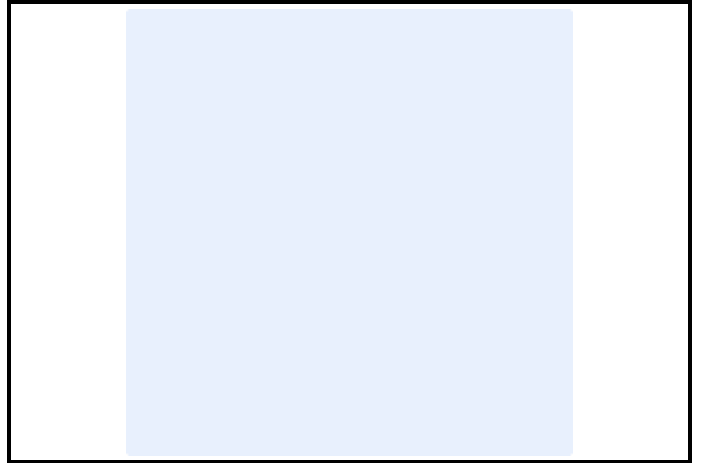

E45)

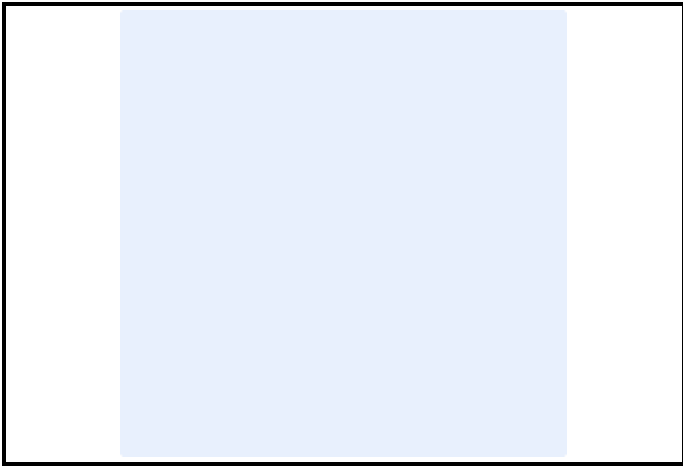

E46)

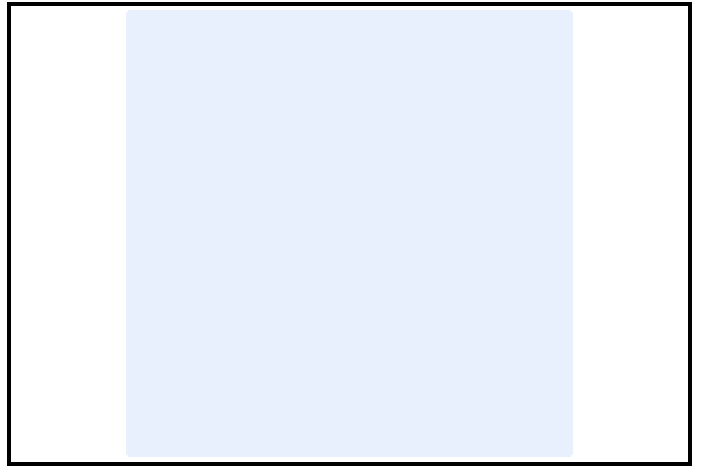

E47)

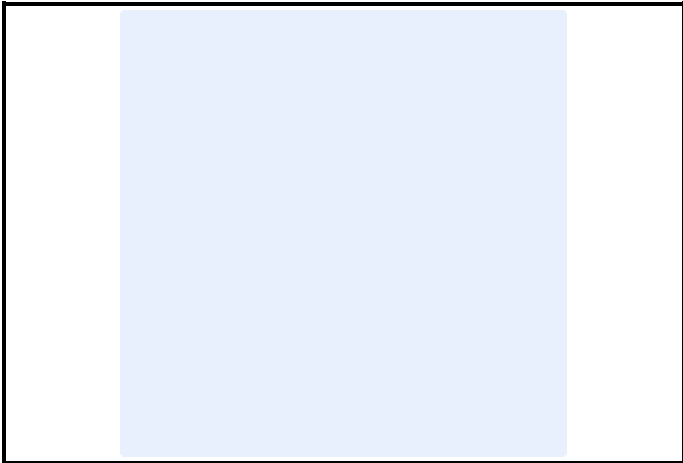

E48)

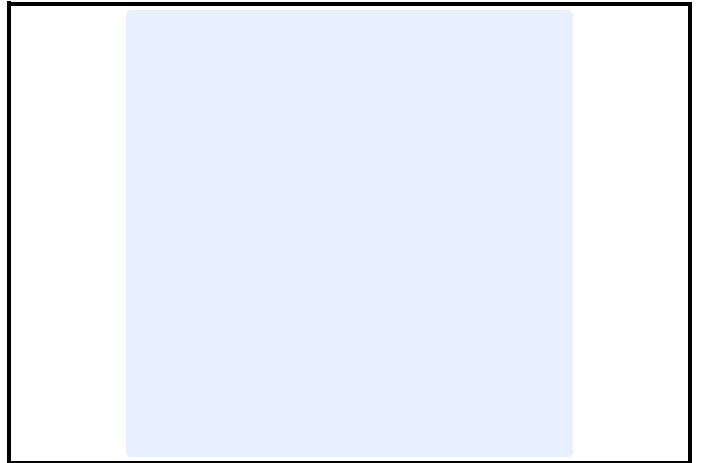

Marque
Make

STILO

Modèle
Model

ST6 ZERO ABP

Homologation N°

AH.031.24-C-ABP

E49)

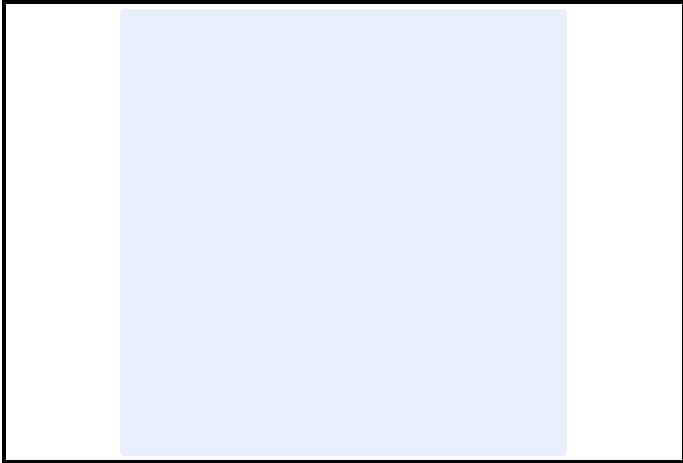

E50)

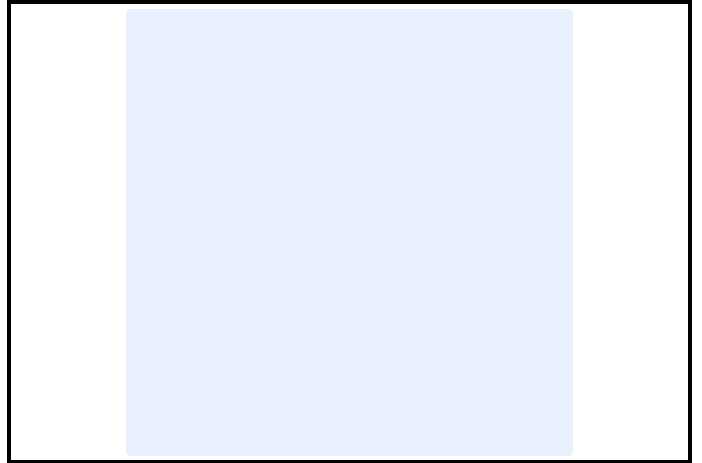

E51)

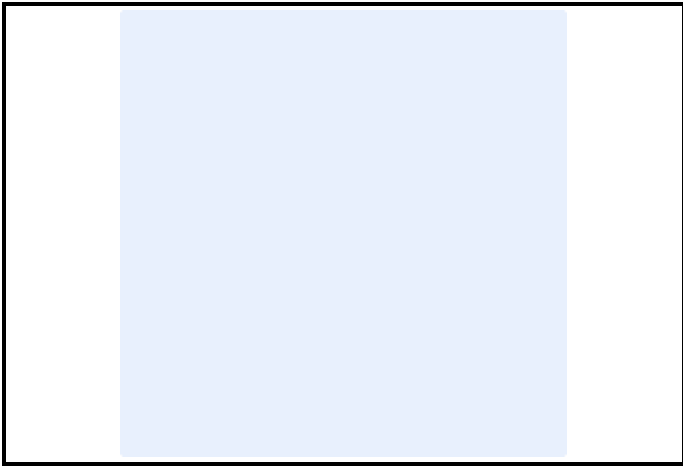

E52)

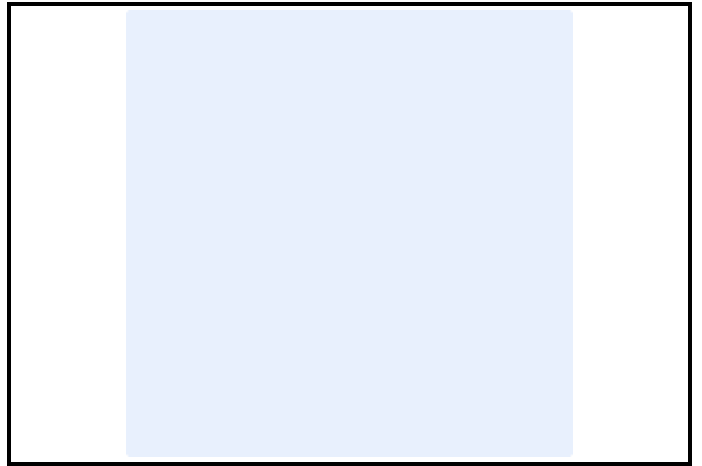

E53)

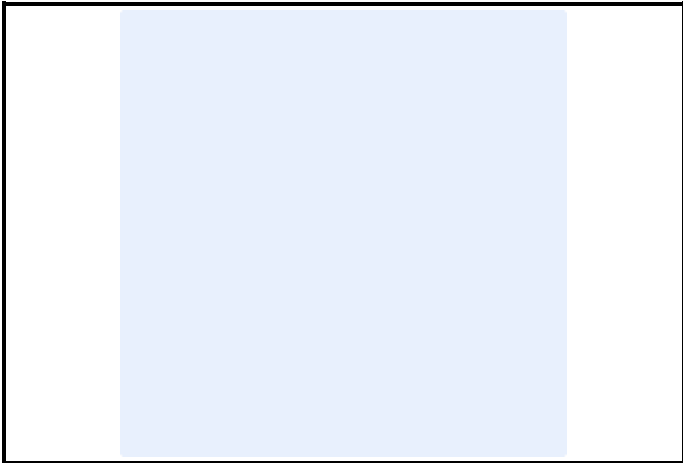

E54)

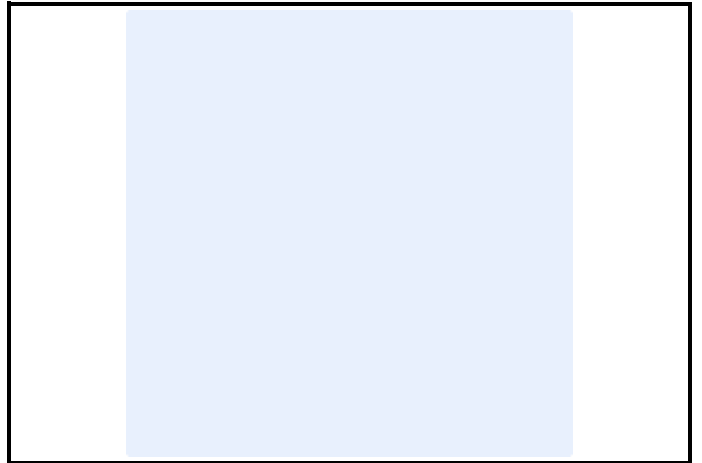

INFORMATIONS COMPLEMENTAIRES / COMPLEMENTARY INFORMATION

Max 10 top ventilation holes

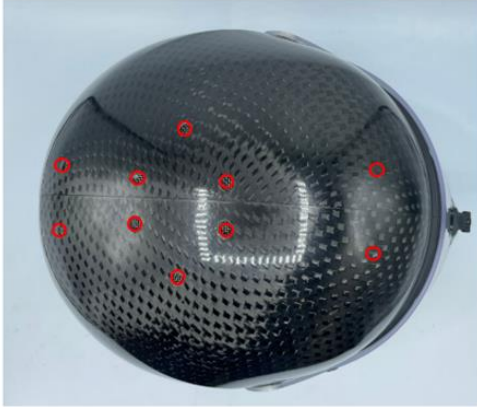

Chin ventilation holes (optional)

